

EAT•N

Aerospace

Fluid Conveyance

Aeroquip® Brand Rynglok®
Tube Repair System

- The proven tube fitting performance standard
- The system of choice for aerospace hydraulic tubing repair
- Approved by Boeing, Airbus, major airlines, and all branches of the U.S. military



Rynglok® Fittings Design Features

A Complete Line of Aerospace Fittings — Permanent, Separable, Specials

- Accommodates all tube all thicknesses
- Capable of joining any combination of tubing materials
- Accommodates tube float up to .40 inches
- All metal 6A1-4V titanium alloy construction
- Zero leakage with no elastomeric seals
- Accommodates -65°F to +450°F without thermal hysteresis effects
- Fitting joint unaffected by long term exposure to high temperature aerospace fluids
- Exceeds tension strength requirements of Boeing BPS-F-142
- Provides torsion strength comparable to that of aerospace tube
- Exceeds flexure requirements of MIL-F-85421 and MIL-F-85720
- Exceeds burst and impulse capability of aerospace tube
- Passes 15 minute fire test with type IIIb low flow rates and vibration per AS1055B
- Patented design provides excellent high current



- lightning strike capability
- Approved for repair used by all major commercial aircraft manufacturers
- Approved for repair used by all branches of U.S. Military
NAVAIR 01-1A-8
USAF T.O. 1-1A-8
NAVAIR 01-1A-20
- Wide variety of fitting configurations incorporated into U.S. Government distribution system
- National Stock Number cross-reference list available upon request

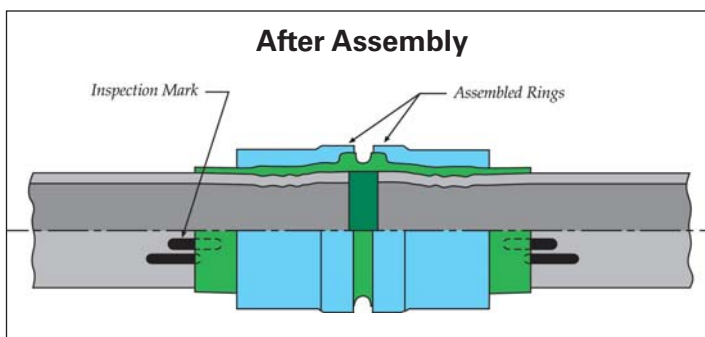
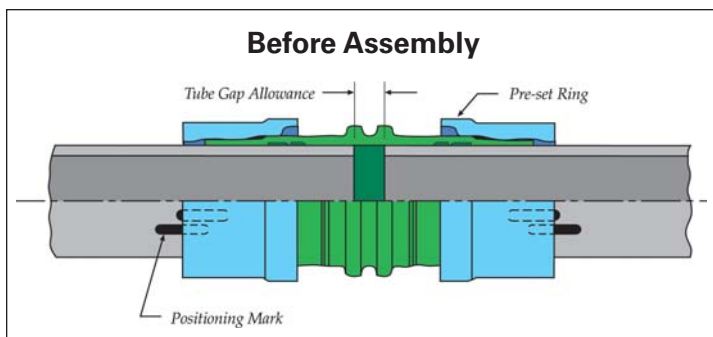

Performance Verification Testing

The superior capability of Eaton's® Rynglok® tube joints has been successfully demonstrated in over 6,000 tests for sealing integrity, flexure fatigue, pressure impulse, burst strength, tensile strength, resistance to torsion, fire and lightning strike conductivity.



Even after undergoing torsion, fire, stress corrosion, impulse, flexure, and thermal shock testing, the Rynglok® tube joints exceed the burst strength of the tubing.



Rynglok® fitting strength often exceeds the torsional strength of the tubing.

Patented Design Feature!

Eaton’s patented Rynglok® design makes it possible to exceed lightning strike requirements by conducting high surface currents “spark free”.

The continuous metal contact insures very low electrical resistance which prevents sparking in critical applications such as aircraft fuel tanks.



Lightning Strike — Spark -Free Connection

Rynglok® Saves Time and Money

Rynglok® simplifies inventory and logistics requirements for both production and repair applications. Rynglok® is capable of handling the numerous classes of fluid systems found in the aerospace industry. Rynglok® fittings are not sensitive to type of tubing used, nor wall thickness.

Rynglok® simplified repair method greatly reduces repair time. The system is not time sensitive and the installation tool head does not require 360 degree access around the tube to be repaired. With Rynglok® there is no need to disconnect long runs of tubing to complete the repair.



The Rynglok® Advantage

- One titanium fitting for all tube materials
- No need for different aluminum, CRESS or titanium fittings
- One titanium fitting for all wall thicknesses
- No need for different 3000, 4000 and 5000 psi fittings

Rynglok® has proven its superior capabilities to repair tube at all pressure ratings used in military and commercial aircraft.

This chart shows that the pressure rating of the Rynglok® fitting exceeds that of a standard aerospace tube.

Tube O.D. (inch)	Titanium Rynglok Fitting Pressure Rating (psi)
3/16	8,000
1/4	8,000
5/16	8,000
3/8	8,000
1/2	8,000
5/8	8,000
3/4	8,000
7/8	4,000
1	5,000
1 - 1/4	4,000
1 - 1/2	2,500

Rynglok® Tooling

Rynglok® Installation Tooling

- One tube diameter - Any tube - One tool. One Rynglok® tool assembles all Rynglok® fittings for a given tube diameter
- Universal tools accommodate both forward (push) and reverse (pull) installation
- Small tool envelope accommodates installation and repair of high density aircraft systems
- Minimal tool head wear
- No tool assembly required
- Rynglok® tools require only 180 degree access to make repairs. Time consuming line disconnection to accommodate 360 degree access is eliminated
- Minimal operator training required
- Tools are constructed of safe low-stressed ductile material
- Time is not a factor in the assembly process
- Rynglok® assembly is simple, repeatable, reliable and safe

Rynglok® Tool Kits

Tool kits for the Rynglok Tube Fitting System can be customized to accommodate your specific requirements.

The kit shown RTSK8-02-002 includes everything that you need to repair any size tube between 3/16" and 1 - 1/2" diameter.



Rynglok® Universal Tools



PUSH

Forward Mode: Ring is being pushed



PULL

Reverse Mode: Ring is being pulled

1. Mark the Tube



Position the marking gage on the end of the cut tube. Use a suitable marking pen to make the position and inspection marks.

2. Position the Fitting



Place the fitting on the tube within the limits of the positioning mark.

3. Position the Tool



When using the tool in the forward mode as shown, position the tool onto the fitting with the tube side of the ring nested into the moveable jaw. If positioned properly, the front end of the tool will be in the fitting groove. Make sure that the fitting is bottomed into the tool.

4. Swaging the Fitting

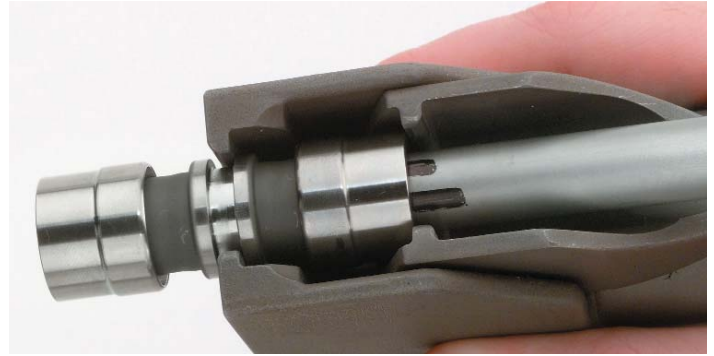

To swage the fitting, apply pressure. Upon completion of swaging, release the pressure, the moveable jaw will return to the original position.

5. Inspect the Installation

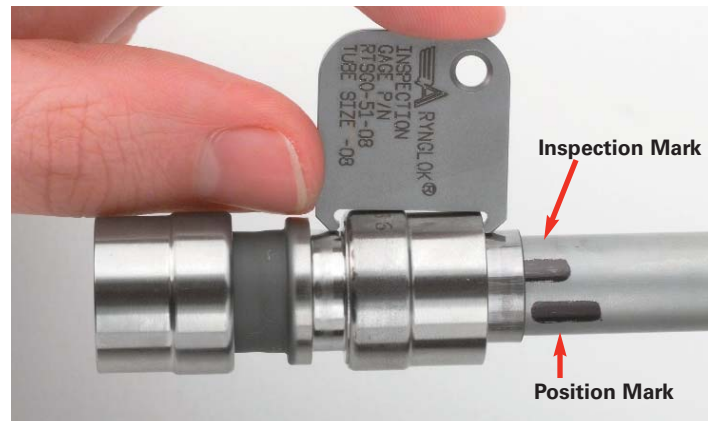

Visually inspect that the ring is fully advanced onto the fitting using the inspection gage. Be sure to verify that the edge of the fitting is within the limits of the inspection mark.

The above steps are repeated for each leg of the Rynglok® fitting.

For a more detailed outline of the Rynglok® installation sequence see our installation bulletin.

Rynglok® Fitting Part Number System and How to Order

Basic Part Number Designation

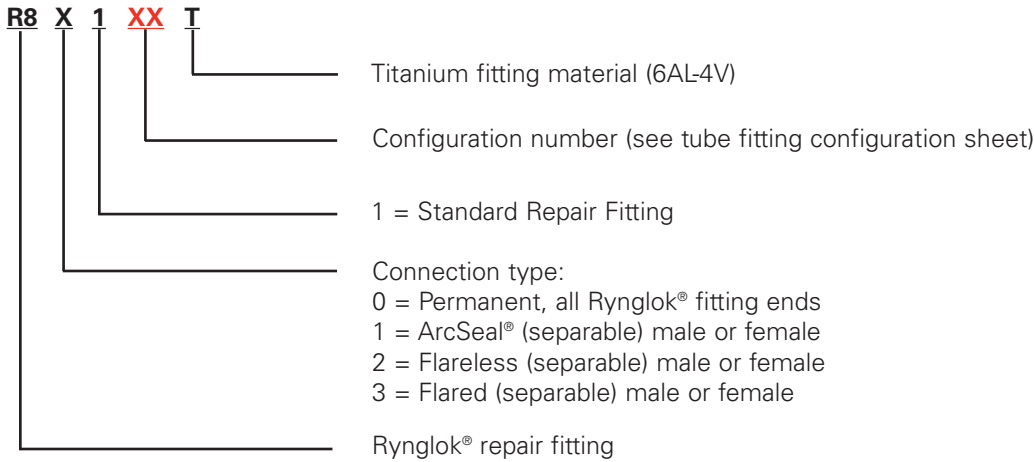

Example: **R81103T**

Rynglok® repair fitting, female ArcSeal® (separable) to Rynglok® fitting in the 90° elbow configuration.

How To Order

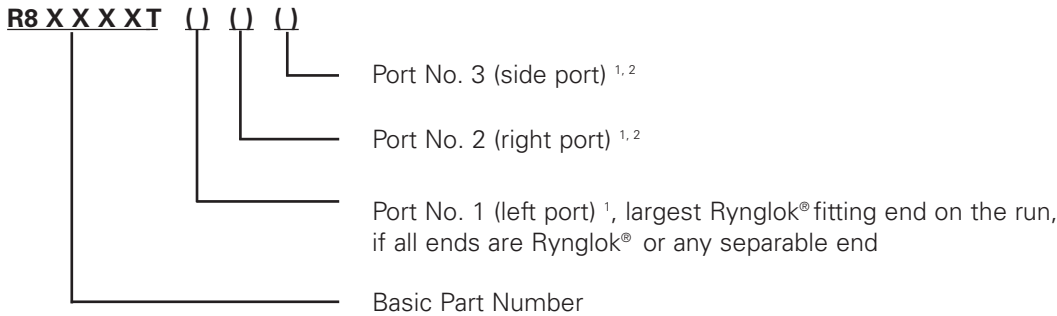

Example: **R80154T100806**

Rynglok® repair fitting, reducing tee, all legs permanent.

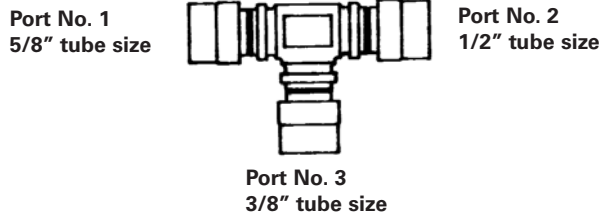

¹ Tube size is specified in 1/16" increments, (i.e., 08 = 8/16ths or 1/2")

² Port 2 and 3 only required for reducer fittings







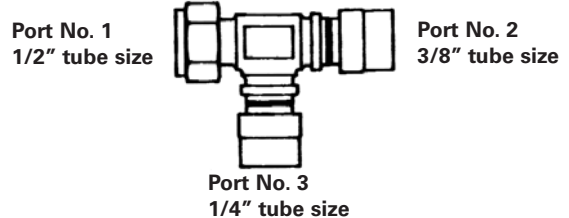



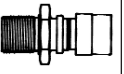
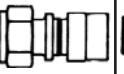
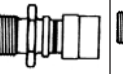
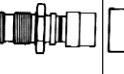
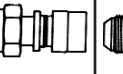
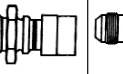
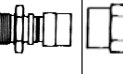

Note: Port numbering system is in accordance with AIR 1590.

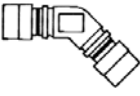
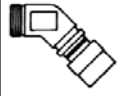
Example: **R81154T080604**

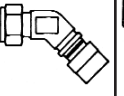
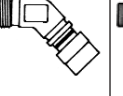
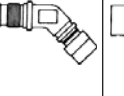
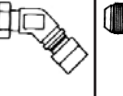
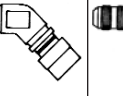
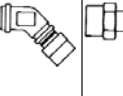
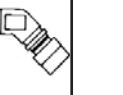
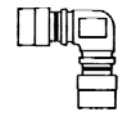
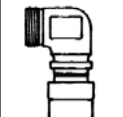
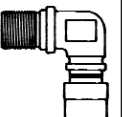
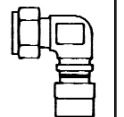
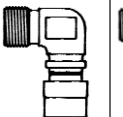
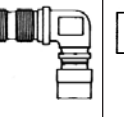
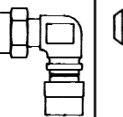
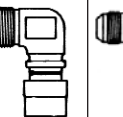
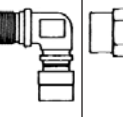
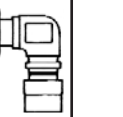
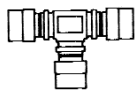
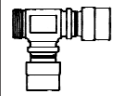
Rynglok® repair fitting, reducing tee, with female ArcSeal® separable.

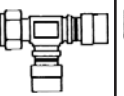
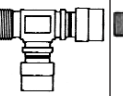
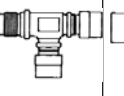
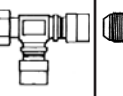
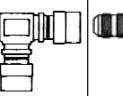
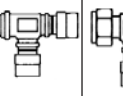
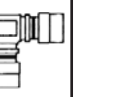

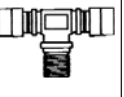
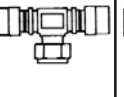
Rynglok® Tube Fitting Configuration

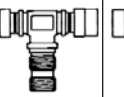
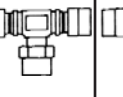
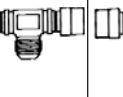
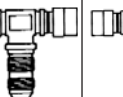
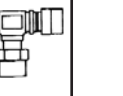
	PERMANENT TO PERMANENT	PERMANENT TO ARCSEAL®			PERMANENT TO "MS" FLARELESS			PERMANENT TO "AN" FLARED		
		MALE MIL-F-85421/1 OR MIL-F-85720/1	MALE MIL-F-85421/1 OR MIL-F-85720/1 BULKHEAD	FEMALE MATES WITH MIL-F-85421 & MIL-F-85720	MALE MS33514	MALE MS33515	FEMALE NAS 1760 MODIFIED	MALE AS4395 (MS33656)	MALE AS4396 (MS33657)	FEMALE AS1708
UNION										
Non-Reducer	R80101T()	R81121T()	R81141T()	R81101T()	R82121T()	R82141T()	R82101T()	R83121T()	R83141T()	R83101T()
Reducer	R80151T()()	R81171T()()	R81191T()()	R81151T()()	R82171T()()	R82191T()()	R82151T()()	R83171T()()	R83191T()()	R83151T()()
45° ELBOW										
Non-Reducer	R80102T()	R81122T()	R81142T()	R81102T()	R82122T()	R82142T()	R82102T()	R83122T()	R83142T()	R83102T()
Reducer	R80152T()()	R81172T()()	R81192T()()	R81152T()()	R82172T()()	R82192T()()	R82152T()()	R83172T()()	R83192T()()	R83152T()()
90° ELBOW										
Non-Reducer	R80103T()	R81123T()	R81143T()	R81103T()	R82123T()	R82143T()	R82103T()	R83123T()	R83143T()	R83103T()
Reducer	R80153T()()	R81173T()()	R81193T()()	R81153T()()	R82173T()()	R82193T()()	R82153T()()	R83173T()()	R83193T()()	R83153T()()
TEE (Separable on Run)										
Non-Reducer	R80104T()	R81124T()	R81144T()	R81104T()	R82124T()	R82144T()	R82104T()	R83124T()	R83144T()	R83104T()
Reducer	R80154T()()	R81174T()()	R81194T()()	R81154T()()	R82174T()()	R82194T()()	R82154T()()	R83174T()()	R83194T()()	R83154T()()
TEE (Separable on Side)										
Non-Reducer		R81126T()	R81146T()	R81106T()	R82126T()	R82146T()	R82106T()	R83126T()	R83146T()	R83106T()
Reducer		R81176T()()	R81196T()()	R81156T()()	R82176T()()	R82196T()()	R82156T()()	R83176T()()	R83196T()()	R83156T()()

Eaton Corporation
Fluid Conveyance
300 South East Avenue
Jackson, Michigan 49203-1972
Phone: (517) 787-8121
Fax: (517) 787-5758
www.aerospace.eaton.com

Eaton Corporation
Fluid Conveyance
Meadowbrook Road
P.O. Box 819
Toccoa, Georgia 30577-0819
Phone: (706) 779-3351
Fax: (706) 779-2638
www.aerospace.eaton.com

Eaton Corporation
Fluid Conveyance
2500 W. Argyle St.
P.O. Box 1845
Jackson, MI 49202-1845
Phone: (517) 787-8121
Fax: (517) 789-4716
www.aerospace.eaton.com

Eaton LTD
Fluid Conveyance
Posttack 1026
Carl -Benz-Strasse 9
D-82205 Gilching
Germany
Phone: (49) 810-575-0
Fax: (49) 810-575-27
www.aerospace.eaton.com

Eaton LTD
Fluid Conveyance
Chemin De Pau
64121 Serres-Castet
France
Phone: (33) 559-333-864
Fax: (33) 559-333-865
www.aerospace.eaton.com

Eaton LTD
Fluid Conveyance
Broad Ground Road
Lakeside
Redditch
Worcs B98 8YS
England
Phone: (44) 152-751-7555
Fax: (44) 152-751-7556
www.aerospace.eaton.com

EAT•N

Aerospace

©2004 Eaton Corporation
All Rights Reserved
Printed in USA
Copying or Editing is Forbidden
Form No. TF100-17
June, 2004