

**EATON**

## Aerospace

Aeroquip® Brand  
Wire Reinforced Synthetic  
Rubber Hose Assemblies

- **Lightweight and Flexible**
- **Qualified to Industry Standards**
- **Integral Abrasion and Fire Resistance Covers Available**

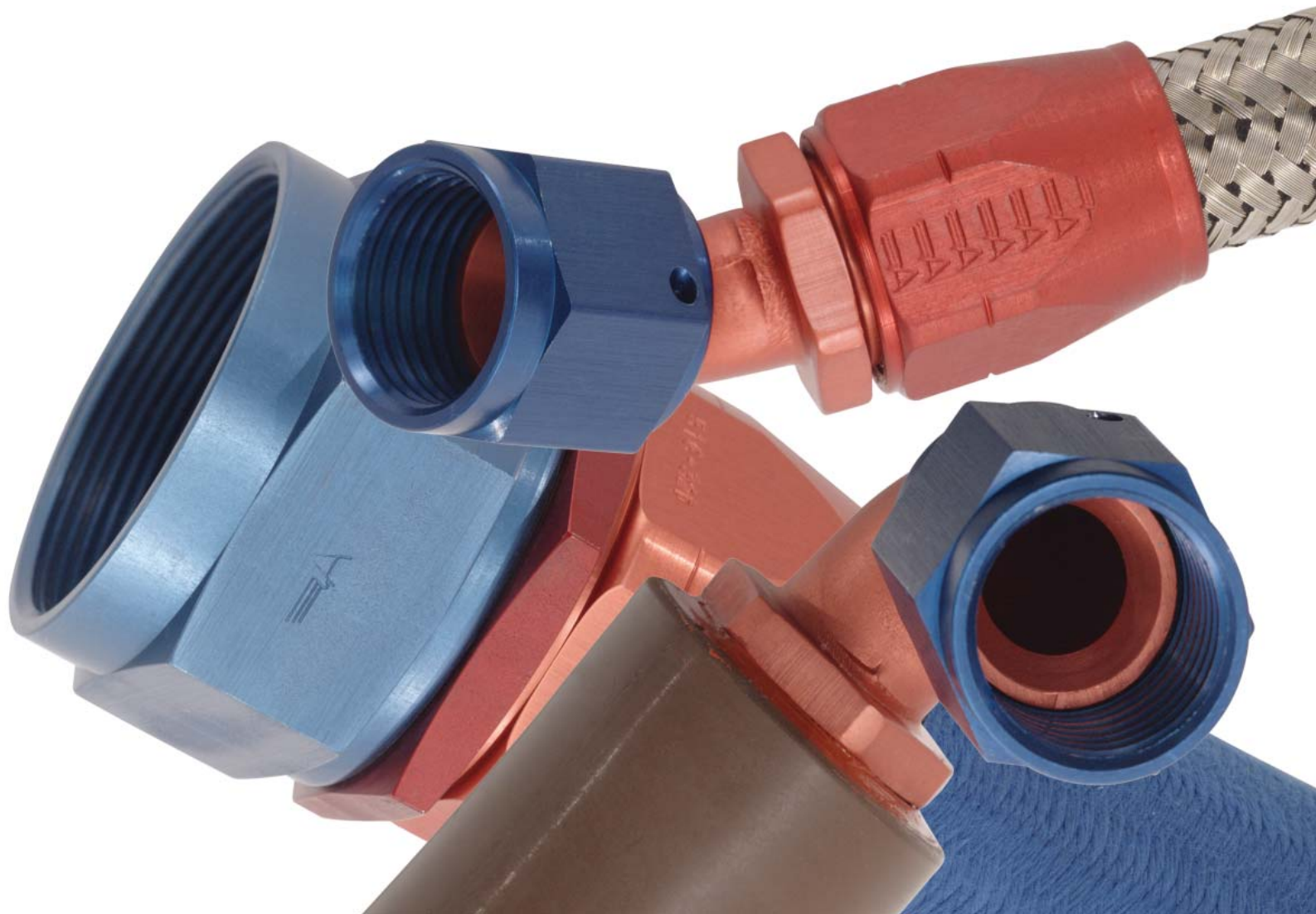

# Aeroquip Brand Wire Reinforced Synthetic Rubber Hose

## 601/AE701 Hose

**Construction:** Synthetic rubber inner tube with two layers of stainless steel wire braid reinforcement.

**Application:** Fuel, engine oil, and coolants.

**Basic Specification:** MIL-H-83797, TSO C53a, Type A.

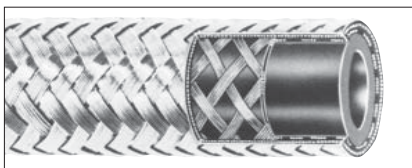

## AE501 Hose

**Construction:** 601/AE701 hose overlaid with a blue braided chafeguard cover of tough polyester yarn.

**Application:** Fuel, engine oil, and coolants.

**Basic Specification:** MIL-H-83797, TSO C53a, Type A.

### Integral Abrasion Resistant Cover



## AE401 Hose

**Construction:** 601/AE701 hose with an integral cover of silicone rubber compound.

**Application:** Fuel, engine oil, and coolants.

**Basic Specification:** MIL-H-83797, TSO C53a, Type C.

### Integral Fire Sleeve



## Design Features

- Flexibility
- Lightweight
- Fluid temperatures: -65°F (-54°C) to +300°F (+149°C)
- TSO C53a, Type A and Type C approvals (with fire sleeve)
- Mil-Spec Approvals:
  - MIL-H-83796/1 through MIL-H-83796/9 Assemblies
  - MIL-H-83797 Hose, MIL-F-83798 Fittings
- Available in sizes -3 thru -32
- Available with polyester/integral sleeve
- Field attachable fittings

NOTE: Hose not intended for vacuum application use. See Mil-H-83797. Hoses that may see intermittent vacuum pressure require an internal support coil. Contact Eaton for additional information.

## End Fitting

Nut: -3, -4 and -5	steel, AMS 5024 (C1137)
Nut: -6 and up	aluminum, AMS 4119 (2024)
Nut Wire: Cres.,	AMS5685 (305)
Nipple: -3, -4 and -5	steel AMS 5024 (C1137)
Nipple: -6 and up	aluminum, AMS4119 (2024)
Elbow: -3, -4 and -5	steel AMS5024
(C1137); -6 and up	aluminum, AMS4117 (6061)
Socket: AMS4117 (6061)	All sizes



## Thread

Size	Thread
-3	.375-24 UNJF-3B
-4	.4375-20 UNJF-3B
-5	.500-20 UNJF-3B
-6	.5625-18 UNJF-3B
-8	.750-16 UNJF-3B
-10	.875-14 UNJF-3B
-12	1.0625-12 UNJ-3B
-16	1.3125-12 UNJ-3B
-20	1.625-12 UNJ-3B
-24	1.875-12 UNJ-3B
-32	2.500-12 UNJ-3B

## Hose Dimensions and Performance Data

Hose Size	-3	-4	-5	-6	-8	-10	-12	-16	-20	-24	-32
601/AE701 Hose O.D. (Max.)	.398	.462	.508	.571	.673	.820	.961	1.187	1.468	1.734	2.140
AE501 Hose O.D. (Max.)	.470	.530	.575	.659	.761	.895	1.053	1.265	1.526	1.800	2.160
AE401 Hose O.D. (Max.)	.721	.755	.801	.864	.966	1.112	1.253	1.465	1.726	2.019	2.436
Hose I.D. (Min.)	.141	.204	.266	.329	.415	.539	.665	.844	1.094	1.344	1.750
Minimum Bend Radius (inches)	1.75	2.00	2.25	2.50	3.50	4.00	4.50	5.50	8.00	9.00	12.50
Operating Pressure (PSI)	1500	1500	1500	1500	1250	1250	1250	1000	800	400	350
Proof Pressure (PSI)3000	3000	3000	3000	2500	2500	2000	1500	1500	1300	800	600
Minimum Burst Pressure (PSI)	6000	6000	6000	6000	5000	5000	4000	3000	2000	2000	1200
601/AE701 Hose Wt. (Lb./Ft.)	.093	.114	.145	.155	.170	.207	.285	.380	.490	.675	.903
AE501 Hose Wt. (Lb./Ft.)	.122	.138	.172	.184	.204	.248	.333	.439	.636	.920	1.138
AE401 Hose Wt. (Lb./Ft.)	.257	.310	.348	.351	.396	.474	.592	.750	.891	1.229	1.471

All dimensions in inches

## Assembly Length

Assembly length is measured from sealing surface to sealing surface. When defining the part number length, measure the length from end point to end point on flareless fittings. With elbow fittings, the measuring point is the intersection of the centerline of the elbow with the face of the sealing surface.

## Rotation Angle Measurement

On assemblies with an elbow fitting on each end, measure the rotation angle as shown. The index angle will follow the basic style hose assembly part number indicated (see example for "double elbow" assemblies). In all cases, the angle should be expressed in 3 digits. For example, 35° should be written as 035. If the angle desired is 0°, specify 000.

## Hose Assemblies

To properly specify the correct hose assembly, use the simple numbering system below. Straight and single elbow assemblies are identified by the number beginning with AE701 and double elbow assemblies are identified by a number beginning with AE70XX. Any assembly can be ordered using these numbers.

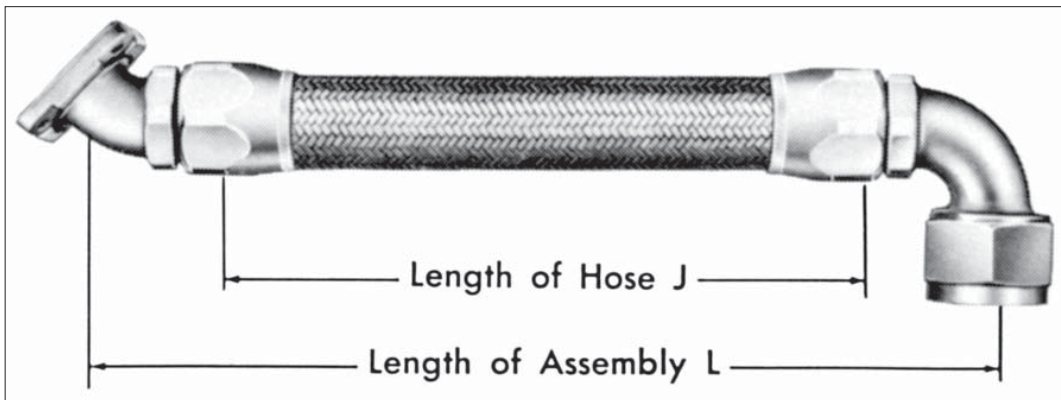

## Assembly Length Tolerances

Up to and including 8 inches:	±.125
Above 8 inches, to and including 16 inches:	±.187
Above 16 inches, to and including 24 inches:	±.250
Above 24 inches, to and including 36 inches:	±.312
Above 36 inches, or longer:	±1%

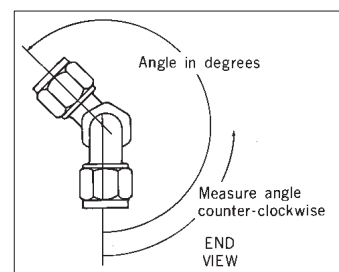

## Bulk Hose

Bulk hose will be supplied in 25-foot lengths whenever possible, but the right is reserved to ship random lengths over 3 feet unless otherwise specified. Contact your Eaton representative if you have questions. An additional charge will be made for hose cut to specified lengths.

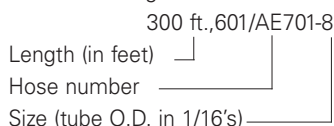

## Examples

### Straight and Single Elbow Hose Assemblies

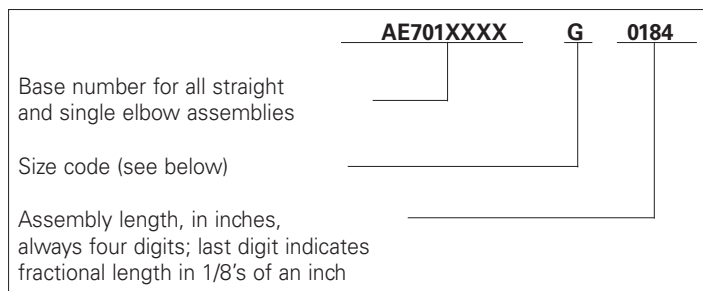

Hose Dash Size	3	4	5	6	8	10	12	16	20	24	32
Letter Code	B	E	F	G	H	J	K	M	N	P	R

### Double Elbow Hose Assemblies

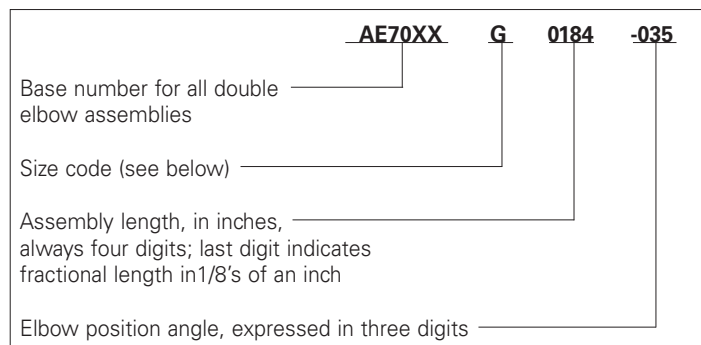

# Flared Fitting

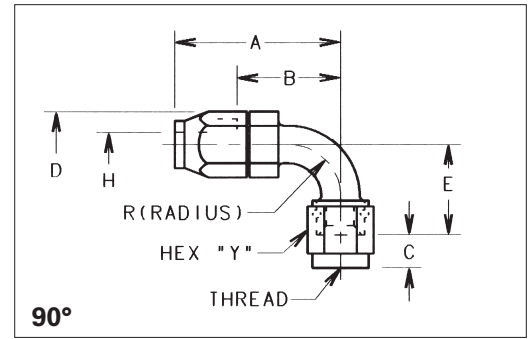
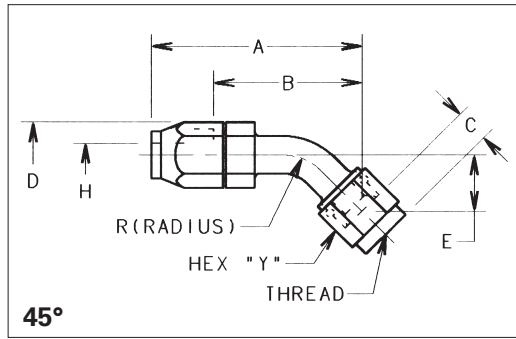
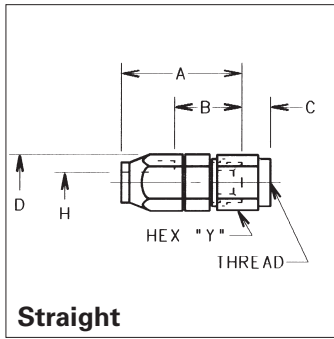

## Straight Fitting Dimensions (M83798/1-Size)

Hose Size	Fitting P/N	Nipple P/N	Max. Dim. A	Dim. B	Dim. C	Max. Dim. D	Dim. R*	Dim. H	Nut Hex***	Socket Hex***	Fitting Wt.**	Dim. E
-3	816-3	526-3	1.30	.64	.34	.64	—	.103	.58	.562	.049	—
-4	816-4	526-4	1.33	.65	.37	.70	—	.150	.65	.625	.061	—
-5	816-5	526-5	1.38	.70	.38	.76	—	.211	.72	.688	.078	—
-6	816-6D	526-6D	1.51	.76	.38	.83	—	.274	.80	.750	.046	—
-8	816-8D	526-8D	1.79	.94	.43	1.04	—	.366	1.01	.875	.078	—
-10	816-10D	526-10D	1.94	.99	.50	1.18	—	.472	1.16	1.062	.108	—
-12	816-12D	526-12D	2.01	1.00	.57	1.47	—	.576	1.45	1.188	.168	—
-16	816-16D	526-16D	2.36	1.16	.60	1.76	—	.781	1.74	1.438	.240	—
-20	816-20D	526-20D	2.64	1.34	.64	2.11	—	1.026	2.11	1.750	.372	—
-24	816-24D	526-24D	2.79	1.44	.74	2.47	—	1.264	2.48	1.938	.504	—
-32	816-32D	526-32D	3.16	1.62	.92	3.20	—	1.684	3.20	2.500	.900	—

## 45° Fitting Dimensions (M83798/2-Size)

-3	8846-3	8746-3	1.74	1.05	.34	.64	.375	.103	.58	.562	.056	.376
-4	8846-4	8746-4	1.72	1.02	.37	.70	.375	.150	.65	.625	.070	.352
-5	8846-5	8746-5	1.83	1.12	.38	.76	.438	.211	.72	.688	.091	.415
-6	8846-6D	8746-6D	2.00	1.22	.38	.83	.500	.274	.80	.750	.052	.446
-8	8846-8D	8746-8D	2.17	1.30	.43	.98	.500	.366	1.01	.875	.085	.457
-10	8846-10D	8746-10D	2.42	1.44	.50	1.17	.625	.472	1.16	1.062	.119	.537
-12	8846-12D	8746-12D	2.79	1.76	.57	1.30	.844	.576	1.45	1.188	.179	.623
-16	8846-16D	8746-16D	3.06	1.83	.60	1.55	.969	.781	1.74	1.438	.255	.659
-20	8846-20D	8746-20D	3.45	2.13	.64	1.91	1.188	1.026	2.11	1.750	.376	.768
-24	8846-24D	8746-24D	3.65	2.28	.74	2.11	1.375	1.264	2.48	1.938	.506	.867
-32	8846-32D	8746-32D	4.26	2.69	.92	2.72	1.750	1.684	3.20	2.500	.891	1.065

## 90° Fitting Dimensions (M83798/3-Size)

-3	8891-3	8791-3	1.58	.89	.34	.64	.375	.103	.58	.562	.057	.752
-4	8891-4	8791-4	1.59	.89	.37	.70	.375	.150	.65	.625	.071	.718
-5	8891-5	8791-5	1.68	.96	.38	.76	.438	.211	.72	.688	.094	.844
-6	8891-6D	8791-6D	1.85	1.07	.38	.83	.500	.274	.80	.750	.053	.922
-8	8891-8D	8791-8D	2.01	1.14	.43	.98	.500	.366	1.01	.875	.088	.938
-10	8891-10D	8791-10D	2.25	1.27	.50	1.17	.625	.472	1.16	1.062	.124	1.126
-12	8891-12D	8791-12D	2.66	1.63	.57	1.30	.844	.576	1.45	1.188	.189	1.376
-16	8891-16D	8791-16D	2.97	1.74	.60	1.55	.969	.781	1.74	1.438	.267	1.500
-20	8891-20D	8791-20D	3.38	2.06	.64	1.91	1.188	1.026	2.11	1.750	.399	1.782
-24	8891-24D	8791-24D	3.59	2.22	.74	2.11	1.375	1.264	2.48	1.938	.538	2.032
-32	8891-32D	8791-32D	4.22	2.65	.92	2.72	1.750	1.684	3.20	2.500	.953	2.532

### All dimensions in inches

DIM. B = Hose cut factor.

DIM. E = Nominal drop dimensions. Tolerance is ±.035" on bent tube fittings.



\*R = Radius of elbow measured to centerline.

\*\*Weight = Nipple assembly plus socket (nominal).

\*\*\* = Distance across corners.

## Socket P/N 516-XXD

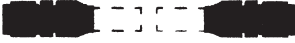
# Hose Assembly/Swivel Flared to Swivel Flared

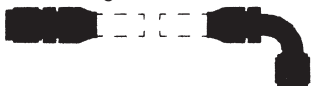
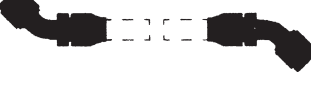
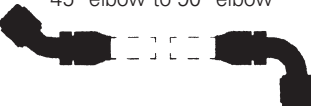
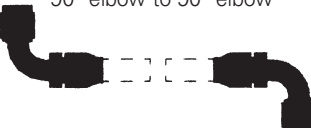
Configurations	Hose Size	601/AE701 Hose Assembly Base No.	AE501 Hose Assembly Base No.	AE401 Hose Assembly Base No.	601/AE701 W/AE102 Firesleeves Hose Assembly Base No.
<p>straight to straight</p> 	-3 thru-32	AE7010000	AE7013110	AE7013106	AE7010001
<p>straight to 45° elbow</p> 	-3 thru-32	AE7010100	AE7013111	AE7013107	AE7010101
<p>straight to 90° elbow</p> 	-3 thru-32	AE7010200	AE7013112	AE7013131	AE7010201
<p>45° elbow to 45° elbow</p> 	-3 thru-32	AE7000	AE7058	AE7074	AE7001
<p>45° elbow to 90° elbow</p> 	-3 thru-32	AE7012	AE7059	AE7075	AE7013
<p>90° elbow to 90° elbow</p> 	-3 thru-32	AE7027	AE7060	AE7076	AE7028

# Flareless Fitting

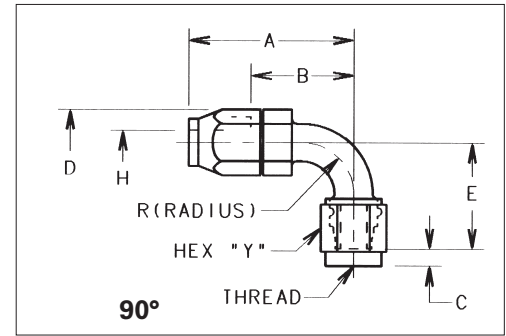
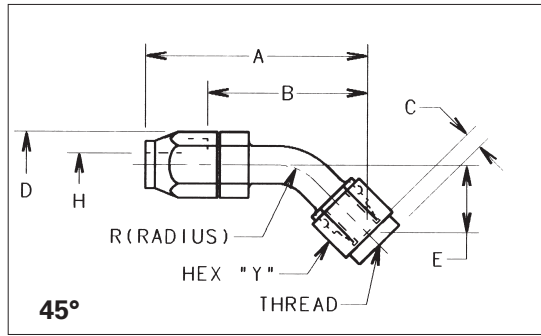
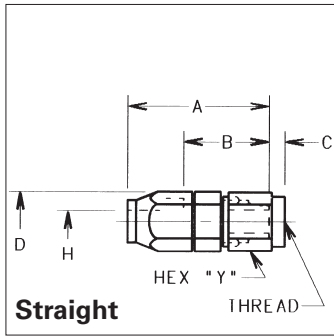

## Straight Fitting Dimensions (M83798/4-Size)

Hose Size	Fitting P/N	Nipple P/N	Dim. A	Dim. B	Dim. C	Dim. D	Dim. R*	Dim. H	Nut Hex***	Socket Hex***	Fitting Wt.**	Dim. E
-3	826-3	536-3	1.52	.85	.13	.64	—	.103	.58	.640	.051	—
-4	826-4	536-4	1.48	.80	.22	.70	—	.150	.654	.703	.064	—
-5	826-5	536-5	1.54	.86	.23	.76	—	.211	.72	.765	.080	—
-6	826-6D	536-6D	1.71	.96	.19	.83	—	.274	.798	.827	.048	—
-8	826-8D	536-8D	2.02	1.17	.21	1.04	—	.366	1.014	.984	.082	—
-10	826-10D	536-10D	2.22	1.26	.24	1.18	—	.472	1.158	1.171	.115	—
-12	826-12D	536-12D	2.28	1.27	.31	1.47	—	.576	1.447	1.296	.175	—
-16	826-16D	536-16D	2.64	1.44	.32	1.76	—	.781	1.736	1.546	.254	—
-20	826-20D	536-20D	2.92	1.62	.37	2.11	—	1.026	2.111	1.906	.368	—
-24	826-24D	536-24D	3.19	1.85	.33	2.47	—	1.264	2.477	2.109	.544	—
-32	—	—	—	—	—	—	—	—	—	—	—	—

## 45° Fitting Dimensions (M83798/5-Size)

-3	—	—	—	—	—	—	—	—	—	—	—	—
-4	880112-4	885112-4	1.72	1.1	.22	.70	.25	.150	.654	.703	.070	.452
-5	—	—	—	—	—	—	—	—	—	—	—	—
-6	880112-6D	885112-6D	2.03	1.36	.19	.83	.50	.274	.798	.827	.054	.578
-8	880112-8D	885112-8D	2.32	1.45	.21	.98	.50	.366	1.014	.984	.088	.610
-10	880112-10D	885112-10D	2.61	1.63	.24	1.17	.62	.472	1.158	1.171	.125	.725
-12	880112-12D	885112-12D	2.97	1.93	.31	1.30	.84	.576	1.447	1.296	.189	.800
-16	880112-16D	885112-16D	3.25	2.03	.32	1.55	.97	.781	1.736	1.546	.270	.854
-20	880112-20D	885112-20D	3.65	2.33	.37	1.91	1.19	1.026	2.111	1.906	.408	.962
-24	—	—	—	—	—	—	—	—	—	—	—	—
-32	—	—	—	—	—	—	—	—	—	—	—	—

## 90° Fitting Dimensions (M83798/6-Size)

-3	—	—	—	—	—	—	—	—	—	—	—	—
-4	880114-4	885114-4	1.59	.89	.22	.70	.25	.150	.654	.703	.070	.860
-5	880114-5	885114-5	1.68	.96	.23	.76	.31	.211	.720	.765	.071	1.000
-6	880114-6D	885114-6D	1.85	1.07	.19	.83	.50	.274	.798	.827	.057	1.112
-8	880114-8D	885114-8D	2.01	1.14	.21	.98	.50	.366	1.014	.984	.092	1.156
-10	880114-10D	885114-10D	2.25	1.27	.24	1.17	.62	.472	1.158	1.171	.130	1.392
-12	880114-12D	885114-12D	2.66	1.63	.31	1.30	.84	.576	1.447	1.296	.199	1.626
-16	880114-16D	885114-16D	2.97	1.74	.32	1.55	.97	.781	1.736	1.546	.282	1.776
-20	880114-20D	885114-20D	3.38	2.06	.37	1.91	1.19	1.026	2.111	1.906	.431	2.056
-24	—	—	—	—	—	—	—	—	—	—	—	—
-32	—	—	—	—	—	—	—	—	—	—	—	—

All dimensions in inches

DIM. B = Hose cut factor.

DIM. E = Nominal drop dimensions. Tolerance is  $\pm .035"$  on bent tube fittings.

\*R = Radius of elbow measured to centerline.

\*\*Weight = Nipple assembly plus socket (nominal).

\*\*\* = Distance across corners.

# Socket P/N 516-XXD

# Hose Assembly/Swivel Flareless to Swivel Flareless

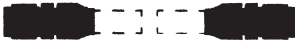
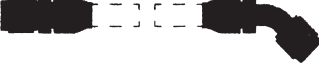
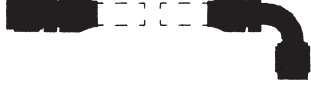
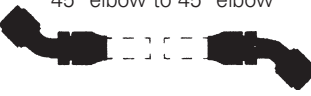
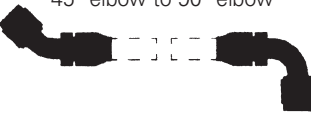
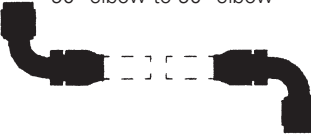
Configurations	Hose Size	601/AE701 Hose Assembly Base No.	AE501 Hose Assembly Base No.	AE401 Hose Assembly Base No.	601/AE701 w/AS1072 Firesleeves Hose Assembly Base No.
<p>straight to straight</p> 	-3 thru-32	AE7010010	AE7013121	AE7013132	AE7010011
<p>straight to 45° elbow</p> 	-3 thru-32	AE7010110	AE7013123	AE7013133	AE7010111
<p>straight to 90° elbow</p> 	-3 thru-32	AE7010210	AE7013125	AE7013134	AE7010211
<p>45° elbow to 45° elbow</p> 	-3 thru-32	AE7003	AE7066	AE7077	AE7004
<p>45° elbow to 90° elbow</p> 	-3 thru-32	AE7015	AE7068	AE7078	AE7016
<p>90° elbow to 90° elbow</p> 	-3 thru-32	AE7030	AE7070	AE7079	AE7031

# Flanged Fitting

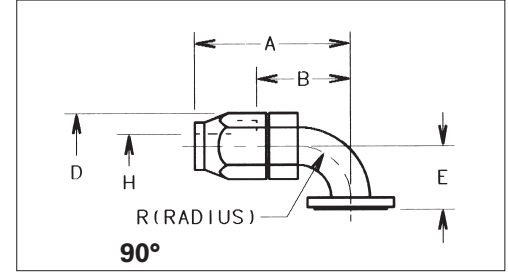
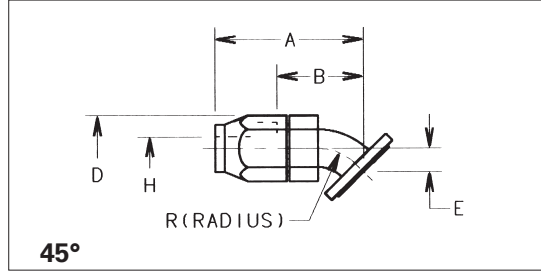
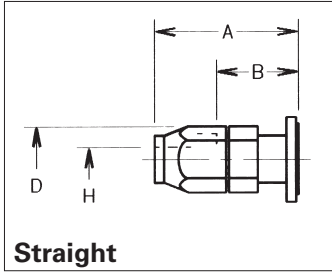

## Straight Fitting Dimensions (M83798/7-Size)

Hose Size	Fitting P/N	Nipple P/N	Max. Dim. A	Dim. B	Dim. C	Max. Dim. D	Dim. R*	Dim. H	Socket Hex***	Fitting Wt.**	Dim. E
-3	—	—	—	—	—	—	—	—	—	—	—
-4	—	—	—	—	—	—	—	—	—	—	—
-5	—	—	—	—	—	—	—	—	—	—	—
-6	—	—	—	—	—	—	—	—	—	—	—
-8	8844-8D	8714-8D	1.97	.84	—	.980	—	.355	.875	.089	—
-10	8844-10D	8714-10D	2.08	.87	—	1.170	—	.472	1.062	.114	—
-12	8844-12D	8714-12D	2.29	1.25	—	1.296	—	.576	1.188	.153	—
-16	8844-16D	8714-16D	2.53	1.30	—	1.546	—	.781	1.438	.206	—
-20	8844-20D	8714-20D	2.83	1.50	—	1.906	—	1.026	1.750	.316	—
-24	8844-24D	8714-24D	2.71	1.34	—	2.109	—	1.264	1.938	.364	—
-32	8844-32D	8714-32D	3.08	1.52	—	2.718	—	1.684	2.500	.646	—

## 45° Fitting Dimensions (M83798/8-Size)

Hose Size	Fitting P/N	Nipple P/N	Max. Dim. A	Dim. B	Dim. C	Max. Dim. D	Dim. R*	Dim. H	Socket Hex***	Fitting Wt.**	Dim. E
-3	—	—	—	—	—	—	—	—	—	—	—
-4	—	—	—	—	—	—	—	—	—	—	—
-5	—	—	—	—	—	—	—	—	—	—	—
-6	—	—	—	—	—	—	—	—	—	—	—
-8	8845-8D	8745-8D	.208	1.18	—	.980	.500	.360	.875	.088	.338
-10	8845-10D	8745-10D	.226	1.28	—	1.170	.625	.472	1.063	.113	.375
-12	8845-12D	8745-12D	2.64	1.60	—	1.296	.844	.576	1.188	.157	.468
-16	8845-16D	8745-16D	2.90	1.68	—	1.546	.969	.781	1.438	.208	.505
-20	8845-20D	8745-20D	3.25	1.93	—	1.906	1.188	1.026	1.750	.321	.569
-24	8845-24D	8745-24D	3.40	2.03	—	2.109	1.375	1.264	1.938	.386	.625
-32	8845-32D	8745-32D	3.92	2.36	—	2.718	1.750	1.684	2.500	.672	.734

## 90° Fitting Dimensions (M83798/9-Size)

Hose Size	Fitting P/N	Nipple P/N	Max. Dim. A	Dim. B	Dim. C	Max. Dim. D	Dim. R*	Dim. H	Socket Hex***	Fitting Wt.**	Dim. E
-3	—	—	—	—	—	—	—	—	—	—	—
-4	—	—	—	—	—	—	—	—	—	—	—
-5	—	—	—	—	—	—	—	—	—	—	—
-6	—	—	—	—	—	—	—	—	—	—	—
-8	8890-8D	8790-8D	2.35	1.48	—	.980	.500	.360	.875	.097	.892
-10	8890-10D	8790-10D	2.51	1.53	—	1.170	.625	.484	1.063	1.123	.896
-12	8890-12D	8790-12D	2.66	1.63	—	1.296	.844	.576	1.188	.164	1.156
-16	8890-16D	8790-16D	2.97	1.74	—	1.546	.969	.781	1.438	.222	1.282
-20	8890-20D	8790-20D	3.38	2.06	—	1.906	1.188	1.026	1.750	.344	1.500
-24	8890-24D	8790-24D	3.54	2.22	—	2.109	1.375	1.264	1.938	.448	1.688
-32	8890-32D	8790-32D	4.21	2.65	—	2.718	1.750	1.684	2.500	.732	2.062

### All dimensions in inches

DIM. B = Hose cut factor.  
 DIM. E = Nominal drop dimensions. Tolerance is  $\pm .035"$  on bent tube fittings.  
 \*R = Radius of elbow measured to centerline.  
 \*\*Weight = Nipple assembly plus socket (nominal).  
 \*\*\* = Distance across corners.

## Socket P/N 516-XXD



# Hose Assembly/4-Hole Flange to 4-Hole Flange

Configurations	Hose Size	601/AE701 Hose Assembly Base No.	601/AE701 w/AS1072 Firesleeves Hose Assembly Base No.
<p>straight to straight</p> 	-8 thru-32	AE7010020	AE7010021
<p>straight to 45° elbow</p> 	-8 thru-32	AE7010120	AE7010121
<p>straight to 90° elbow</p> 	-8 thru-32	AE7010220	AE7010221
<p>45° elbow to 45° elbow</p> 	-8 thru-32	AE7006	AE7007
<p>45° elbow to 90° elbow</p> 	-8 thru-32	AE7018	AE7019
<p>90° elbow to 90° elbow</p> 	-8 thru-32	AE7033	AE7034

# How to assemble 601/AE701 Hose Assemblies with "little gem" Straight Fittings and Elbows

To make hose assembly of length "L" cut hose to length "J". Obtain "J" length by subtracting proper fitting allowances. See "B" dimensions on fitting pages.

## Straight Fittings

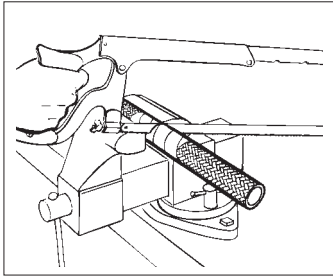

**Step 1.**  
Cut hose squarely to length. Use hose cut-off machine or fine tooth hacksaw. To minimize wire braid flare-out, wrap hose with masking tape and saw through tape. Remove tape before step 2.

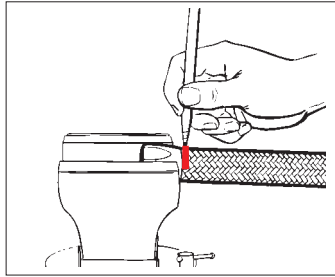

**Step 2.**  
Insert hose in socket with a twisting, pushing motion until hose is in line with back of socket threads.

**Step 3.**  
Important – mark hose position around hose at rear of socket. Use a grease pencil, painted line or tape.

**Step 4.**  
Lubricate inside of hose and nipple threads liberally. Use SAE30 lubricating oil. Avoid getting oil in the cutting spur of the nipple.

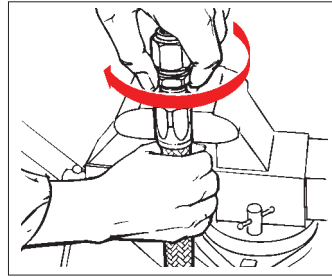

**Step 5.**  
Carefully insert nipple and engage nipple and socket threads while holding hose in position with other hand. Make sure that hose does not push out of socket by observing mark made in step 3.

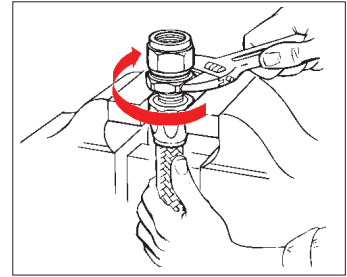

**Step 6.**  
Complete assembly using wrench while continuing to hold in position. Maximum allowable gap is .041 inches in sizes 3, 4 and 5, and .031 inches in size 6 and up.

**Step 7.**  
IMPORTANT – check for hose push-out by observing hose position mark. None should be evident. Clean, inspect and proof test.

Note: Hose push-out after proof test should not exceed 1/32 inch or size 12 and up. None is allowable on smaller sizes.

## Elbow Fittings

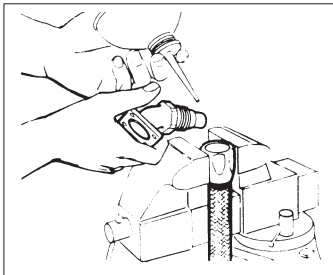

**Step 1.**  
Follow through steps 1, 2, and 3, above.

**Step 2.**  
Flange elbow fittings. Drop flange over threaded end of nipple. Nipple shoulder must fit into counterbore of flange.

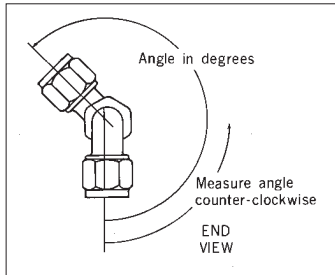

**Step 4.**  
Carefully insert nipple and engage nipple and socket threads while holding hose in position with other hand. Make sure hose does not push out of socket by observing mark.

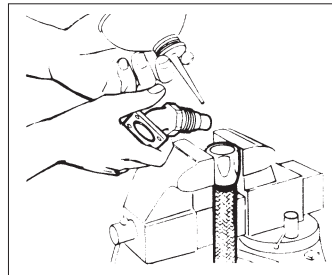

**Step 5.**  
Complete assembly using wrench on elbow hex while continuing to hold hose in position. Tighten until hex is snug against socket. On forged elbow, use wrench on forging flats. Tighten until shoulder is snug against socket.

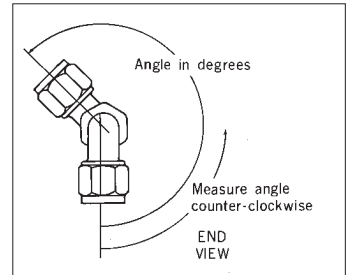

**Step 6.**  
Adjustments may be necessary to obtain the desired position angle between two elbows. In order to minimize backing off elbows to position, the following procedure should supplement step 5:

- Tighten both elbows to within .031 inches of socket then start to position for relative angle between elbows.
- Finish assembly by adjusting both elbows. Backing-off to position should be avoided and in no case should exceed 1/4 turn. Maximum allowable gap between hex and socket is .031 inches.

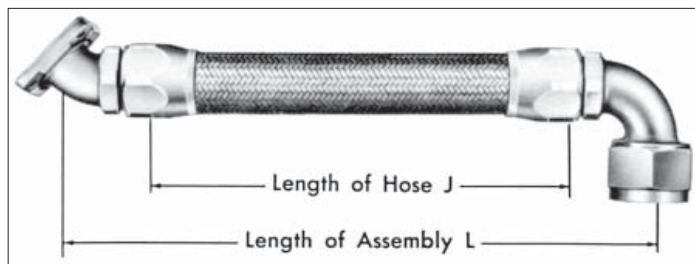

**Step 3.**  
Lubricate inside of hose and nipple threads liberally. Use SAE30 lubricating oil. Avoid getting oil in the cutting spur of the nipple.

**Step 7.**  
IMPORTANT – check for hose push-out. See step 6 above. Clean, inspect and proof test.

Note: Hose push-out after proof test should not exceed 1/32 inch on sizes 12 and up. None is allowable on smaller sizes.

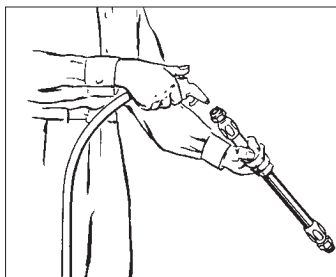

**Clean**

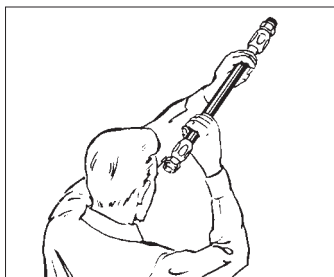

**Inspect**

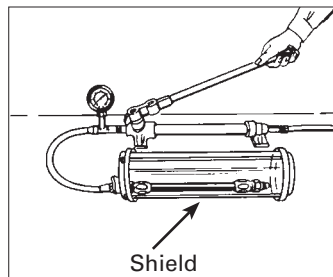

**Proof Test/Fluid**

## Clean, Inspect, Proof Test

**CLEAN...**Clean hose after cutting to length. Be sure all cutting residue is dislodged. After assembly, clean each hose assembly internally using clean, dry compressed air.

**INSPECT...**Examine hose assembly internally for cut or bulged inner tube, obstructions and cleanliness. Examine Aeroquip hose assemblies with *"little gem"* fittings for hose push-out. Inspect for proper gap between nut and socket or hex and socket. Nuts should swivel freely.

**PROOF TEST...**Test hose assemblies in straight, horizontal position and observe for evidence of leakage while maintaining test pressure. Several hose assemblies may be tested at one time by connecting them in series.

1. **LIQUID TEST MEDIUM...** tighten cap only after all trapped air has bled from assembly. Use a heavy plastic protective cover when applying pressure.

2. Use proper proof-test fluid specified for hose:
3. Drain and cap.
4. Corrosion protection of fittings on hose assemblies.

- a Brass, corrosion resistant steel, and aluminum alloy fittings require no additional treatment.
- b Fittings on air or instrument hose assemblies should not be oiled. Dry thoroughly and

cap with oil and grease-free caps.

### Storage and Handling

1. **BULK HOSE AND HOSE ASSEMBLIES...**hose should be stored away from sunlight, heat, ozone, etc. To minimize obsolescence or deterioration of hose in storage, follow "first-in, first-out" principle in releasing stock for production or shipment.

2. Short hose lengths or assemblies may be conveniently stored in closed containers to protect from dust. Other hose assemblies should have the ends capped. Hose assemblies made up in the field should be marked with the date of assembly before being placed in storage.

NOTE: All hose assemblies taken from storage should be proof-tested prior to installation in aircraft.

Type	Hose No.	Proof Test Fluid
Pneumatic fuel, oil and coolant	601/AE701	Hydraulic oil (MIL-H-5606)* or water

\*Flush after proof-testing using oleum or other neutral spirits.

## **WARNING**

FAILURE OR IMPROPER SELECTION, USE, OR ASSEMBLY OF THE PRODUCTS AND COMPONENTS FOR APPLICATIONS DESCRIBED HEREIN CAN RESULT IN POSSIBLE PROPERTY DAMAGE, PERSONAL INJURY OR DEATH.

This document and any other related information from Eaton® Aeroquip® or its affiliates and authorized distributors, provide product options for consideration by Users having

technical expertise with these products. Due to the wide variety of applications and operating conditions for these products and components, the User is solely responsible for making the final selection of the products and ensuring that all performance, safety and warning requirements for the User's intended application are met.

Eaton Aeroquip recommends that Eaton® Aeroquip® hose, fittings

or assembly equipment must be used only with other Eaton® Aeroquip® hose, fittings or assembly equipment, and Eaton Aeroquip and/or its affiliates disclaim any obligation or liability (including all incidental and consequential damages) to the extent Eaton® Aeroquip® hose, fittings or assembly equipment is used with any other manufacturer's hose, fittings or assembly equipment or in the event that Eaton Aeroquip recommended processes and

product instructions for hose assemblies are not followed.

The products described herein, including product features, specifications, designs, and availability are subject to change at any time without notice.

**Eaton Corporation**  
**Conveyance Systems Division**  
300 South East Avenue  
Jackson, Michigan 49203-1972  
Phone: (517) 787-8121  
Fax: (517) 787-5758

**Eaton Corporation**  
**Conveyance Systems Division**  
Route 2 Box 361  
Meadowbrook Road  
Eastanollee, Georgia 30538  
Phone: (706) 779-3351  
Fax: (706) 779-2638

**Eaton Corporation**  
**Conveyance Systems Division**  
11642 Old Baltimore Pike  
Beltsville, Maryland 20705  
Phone: (301) 937-4010

**Eaton Corporation**  
**Conveyance Systems Division**  
15 Pioneer Ave.  
Warwick, Rhode Island 02888  
Phone: (401) 781-4700

**Eaton Corporation**  
**Conveyance Systems Division**  
671 W. 17th Street  
Costa Mesa, California 92627  
Phone: (949) 548-3421  
Fax: (949) 752-2997

**Eaton LTD**  
**Conveyance Systems Division**  
Broad Ground Road  
Lakeside  
Redditch  
Worcs B98 8YS  
England  
Phone: (44) 152-751-7555  
Fax: (44) 152-751-7556

**Eaton S.A.**  
**Conveyance Systems Division**  
2 Rue Lavoisier BP 54 78310  
Coignieres, France  
Phone: (33) 1-30-69-3000

**Eaton LTD**  
**Conveyance Systems Division**  
Chemin De Pau  
64121 Serres-Castet  
France  
Phone: (33) 559-333-864  
Fax: (33) 559-333-865

**Eaton LTD**  
**Conveyance Systems Division**  
Posttack 1026  
Carl -Benz-Strasse 9  
D-82205 Gilching  
Germany  
Phone: 49 (0) 8105-750  
Fax: 49 (0) 8105-7555

**Vickers Systems Pte Ltd**  
**Conveyance Systems Division**  
Lot 512, Jalan Delima, Batamindo  
Industrial Park  
Batam 29433, Indonesia  
Phone: (62) 611823

