



**Aerospace**  
**Fluid Conveyance**

Aeroquip® Brand Rubber Hose,  
Fittings & Assemblies for  
Aerospace Applications

- Light Weight and Flexible
- Qualified to Industry Standards



# Table of Contents

---

306 Low Pressure Hose, Fittings and Assemblies	3
303, 302A Medium Pressure Hose, Fittings and Assemblies	4
303, 302A Medium Pressure, Flared Hose Assemblies, Sizes -4 through -10	5
303, 302A Medium Pressure, Flared Hose Assemblies, Sizes -12 through -32	5
303, 302A Medium Pressure, Flareless Fittings and Assemblies	6
Aircraft Rubber Hose Assembly Instructions	7
Hose Cut-Off Factors	8
Rubber Hose Assembly Equipment	9

# 306 Low Pressure Hose, Fittings and Assemblies

## Construction:

- *Inner Tube:* seamless synthetic rubber compound
- *Reinforcement:* single cotton braid
- *Outer Cover:* synthetic rubber cover

## Operating Temperatures:

-65° to +160°F

## Identification:

Black cover with linear yellow indicator stripe interspersed with symbol "LP"; hose manufacturer's code, size and date of manufacture (quarter year/year). Spaced 180° from this is "Aeroquip 306" in a white stripe. Markings repeated six inches apart.

## Application:

Air or vacuum instrument systems, automatic pilots and lines to pressure gauges used with these systems as specified in MS33620. Hose assemblies conform to AN6270. Hose conforms to MIL-DTL-5593. Fittings conform to MIL-DTL-38726 and MS27404.\*

\* Supersedes AN773

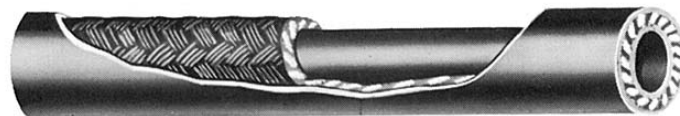

306 Hose / MIL-DTL-5593

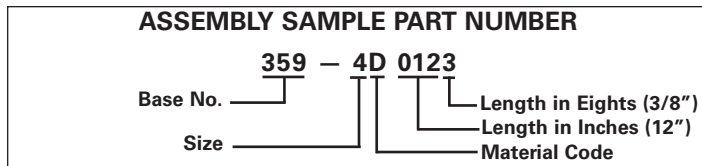

COMPLETE ASSEMBLY Including 471 Fittings			HOSE							
Part No.	Tube Size O.D.	Weight 12" Ass'y (lbs.)	Part No.	Hose Size I.D.	Hose Size O.D.	Max. Oper. P.S.I.	Min. Proof P.S.I.	Min. Burst P.S.I.	Min. Bend radii	Weight per inch (lbs.)
359-2DL AN6270-2-L	1/8	.061	306-2 MILDTL5593-2	.125	.344	300	600	2000	2.00	.004
359-3DL AN6270-3-L	3/16	.080	306-3 MILDTL5593-3	.188	.406	250	500	1700	2.00	.005
359-4L AN6270-4-L	1/4	.106	306-4 MILDTL5593-4	.250	.469	200	400	1250	4.00	.006
359-6DL AN6270-6-L	3/8	.145	306-6 MILDTL5593-6	.375	.594	150	300	1000	4.00	.008
359-8DL AN6270-8-L	1/2	.236	306-8 MILDTL5593-8	.500	.750	150	250	750	6.00	.012
359-10DL AN6270-10-L	5/8	.292	306-10 MILDTL5593-10	.625	.875	150	250	700	6.00	.014

## Flared AN818 Swivel Nut

- 359 Assembly AN6270
- To mate with MS33656, MS33657, AS4395, AS4396



Length of Assembly

HOSE FITTING					SOCKET			NIPPLE		NUT			
Part No.	Max. Dim. A	Dim. B	Dim. C	Weight (lbs.)	Part No.	Dim. F	Max. Dim. K	Part No.	Min. Dim. H	Part No.	Dim. M	Max. Dim. N	Thread T
471-2D MS27404-2D*	.88	.40	.34	.008	213-2D	.531	.453	231-2D	.059	290-2D	.375	.436	5/16 - 24
471-3D MS27404-3D*	1.00	.44	.32	.012	213-3D	.562	.516	231-3D	.122	290-3D	.438	.509	3/8 - 24
471-4D MS27404-4D*	1.04	.47	.35	.020	213-4D	.625	.578	231-4D	.169	290-4D	.563	.654	7/16 - 20
471-6D MS27404-6D*	1.15	.54	.38	.029	213-6D	.650	.703	231-6D	.294	290-6D	.688	.798	9/16 - 18
471-8D MS27404-8D*	1.37	.67	.43	.054	213-8D	.800	.891	231-8D	.388	290-8D	.875	1.014	3/4 - 16
471-10D MS27404-10D*	1.57	.72	.51	.072	213-10D	.950	.953	231-10D	.481	290-10D	1.000	1.158	7/8 - 14

All dimensions in inches.

\* Supersedes AN773.

## Material & Finish:

Nut, nipple and socket are anodized aluminum. All materials and finishes conform to applicable specifications for end fittings used in aircraft fluid systems.

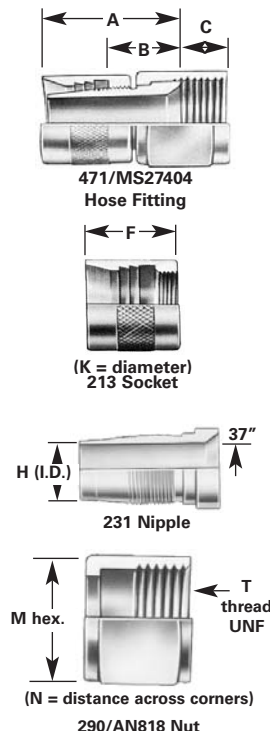

# 303, 302A Medium Pressure Hose, Fittings, and Assemblies

## Construction:

- **Inner Tube:** seamless synthetic rubber compound
- **Reinforcement:** synthetic impregnated single-wire braid over single cotton braid
- **Outer Cover:** synthetic impregnated oil-resistant cotton braid

## Operating Temperatures:

- 303 Hose: -65° to +250°F
- 302A Hose: -40° to +250°F

## Identification:

Grey-black braided cover with linear yellow marking consisting of — "MIL-DTL-8794 ,size, date of manufacture (quarter year/year) and hose manufacturer's code." Spaced 90° from this is a yellow indicator stripe interspersed with "Aeroquip 303" or "Aeroquip 302A." Markings repeated nine inches apart.

## Application:

Medium pressure hydraulic, pneumatic, fuel, oil and coolant systems specified in MS33620. Hose assemblies conform to MIL-DTL-8795 and MS28741. Hose conforms to MIL-DTL-8794. Fittings conform to MIL-A-5070 and MS24587.\* Hose may be used in submerged applications.

\* Supersedes MS28740, fittings dimensionally and functionally interchangeable.



303, 302A/ MIL-DTL-8794 Hose

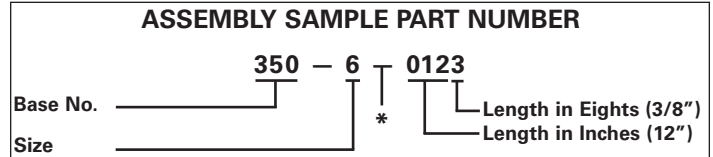

\* Use D instead of (-) after size for -8 and larger

COMPLETE ASSEMBLY Including 491 Fittings			HOSE							
Part No.	Tube Size O.D.	Weight 12" Ass'y (lbs.)	Part No.	Hose Size I.D.	Hose Size O.D.	Max. Oper. P.S.I.	Min. Proof P.S.I.	Min. Burst P.S.I.	Min. Bend radii**	Weight per inch (lbs.)
350-3-L † MS28741-3-L	3/16	.175	303-3 MIL-DTL-8794-3	.125	.453	3000	6000	12000	3.00	.010
350-4-L †† MS28741-4-L	1/4	.228	303-4 MIL-DTL-8794-4	.188	.516	3000	6000	12000	3.00	.011
350-5-L MS28741-5-L	5/16	.279	303-5 MIL-DTL-8794-5	2.50	.578	3000	5000	10000	3.38	.013
350-6-L MS28741-6-L	3/8	.391	303-6 MIL-DTL-8794-6	.313	.672	2000	4500	9000	4.00	.019
360-8-DL MS28741-8-L	1/2	.417	303-8 MIL-DTL-8794-8	.406	.766	2000	4000	8000	4.62	.022
360-10-DL MS28741-10-L	5/8	.580	303-10 MIL-DTL-8794-10	.500	.922	1750	3500	7000	5.50	.031
360-12-DL MS28741-12-L	3/4	.750	303-12 MIL-DTL-8794-12	.625	1.078	1500	3000	6000	6.50	.038
390A16DL MS28741-16-L	1	.824	302A16 MIL-DTL-8794-16	.875	1.234	800	1600	3200	7.38	.037
390A20DL MS28741-20-L	1 1/4	1.274	302A20 MIL-DTL-8794-20	1.125	1.500	600	1250	2500	9.00	.043
390A24DL MS28741-24-L	1 1/2	1.558	302A24 MIL-DTL-8794-24	1.375	1.750	500	1000	2000	11.00	.056
390A32DL MS28741-32-L	2	2.453	302A32 MIL-DTL-8794-32	1.812	2.219	350	700	1400	13.25	.078

\*\* At maximum operating pressure.  
† Not to be used in hydraulic systems.

\*\* May be used where dynamic impulse does not exceed 3750 psi. If dynamic impulses of 4500 psi are required MIL-H-8790 hose assemblies shall be used.

## Flared AN818 Swivel Nut

- 350, 360, 390A Assembly MS28741
- To mate with MS33656, MS33657, AS4395, AS4396



HOSE FITTING					SOCKET			NIPPLE		NUT			
Part No.	Max. Dim. A	Dim. B	Dim. C	Weight (lbs.)	Part No.	Dim. F	Max. Dim. K	Part No.	Min. Dim. H	Part No.	Dim. M	Max. Dim. N	Thread T
491-3 *MS24587-3	1.43	.65	.32	.034	210-3D MS24590-3	1.000	.630	251-3 MS24588-3	.123	290-3	.438	.51	3/8 - 24
491-4 *MS24587-4	1.51	.65	.35	.055	210-4D MS24590-4	1.100	.693	251-4 MS24588-4	.170	290-4	.563	.65	7/16 - 20
491-5 *MS24587-5	1.64	.74	.38	.071	210-5D MS24590-5	1.200	.755	251-5 MS24588-5	.232	290-5	.625	.72	1/2 - 20
491-6 *MS24587-6	1.79	.77	.38	.096	210-6D MS24590-6	1.300	.880	251-6 MS24588-6	.295	290-6	.688	.80	9/16 - 18
491-8D *MS24587-8	2.22	.94	.43	.097	210-8D MS24590-8	1.650	1.005	251-8D MS24588-8	.390	290-8D	.875	1.01	3/4 - 16
491-10D *MS24587-10	2.42	1.00	.51	.135	210-10D MS24590-10	1.800	1.234	251-10D MS24588-10	.484	290-10D	1.000	1.16	7/8 - 14
491-12D *MS24587-12	2.70	1.00	.57	.185	210-12D MS24590-12	2.100	1.359	251-12D MS24588-12	.608	290-12D	1.250	1.45	1 1/16 - 12
491-16D *MS24587-16	2.34	.94	.60	.220	210-16D MS24591-16	1.661	1.546	251-16D MS24589-16	.810	290-16D	1.500	1.74	1 5/16 - 12
491-20D *MS24587-20	2.48	1.00	.64	.422	210-20D MS24591-20	1.750	1.921	251-20D MS24589-20	1.042	290-20D	2.000	2.33	1 5/8 - 12
491-24D *MS24587-24	2.67	1.09	.74	.504	210-24D MS24591-24	1.845	2.124	251-24D MS24589-24	1.276	290-24D	2.250	2.62	1 7/8 - 12
491-32D *MS24587-32	3.21	1.24	.93	.850	210-32D MS24591-32	2.250	2.640	251-32D MS24589-32	1.745	290-32D	2.875	3.34	2 1/2 - 12

All dimensions in inches.

\* Supersedes MS28740, fittings dimensionally and functionally interchangeable.

## Material & Finish:

Nut and nipple, sizes 3 through 6, cadmium-plated steel. Nut and nipple sizes 8 and up, and socket, anodized aluminum. All materials and finishes conform to applicable specifications for end fittings used in aircraft fluid systems.

Elbow fittings are available for 303, 302A hose.

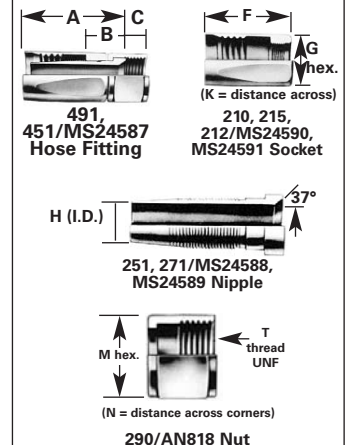

# 303, 302A Medium Pressure, Flared Hose Assemblies

## -4 through -10 and -12 through -32

### -4 through -10 Flared AN818 Swivel Nut Fittings and Assemblies

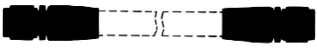
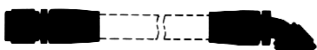
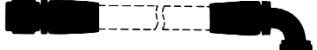
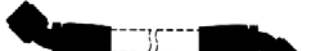
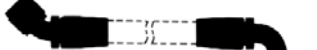
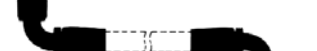
Fitting A	Fitting B	Type	Material	Fitting A Part No.	Assembly Base No.	Fitting B Part No.
		Unsleeved	Alum.	491	360	491
			Alum.	451	390A	451
			Steel	491	350	491
		Firesleeve	Alum.	491 or 451	624000	491 or 451
			Steel	491 or 451	624000	491 or 451
		Unsleeved	Alum.	491 or 451	950012	980006
			Steel	491 or 451	950012	980006
		Firesleeve	Alum.	491 or 451	624040	980006
Steel	491 or 451		624040	980006		
		Unsleeved	Alum.	491 or 451	950004	980005
			Steel	491 or 451	950004	980005
		Firesleeve	Alum.	491 or 451	624023	980005
Steel	491 or 451		624023	980005		
		Unsleeved	Alum.	980006	950010	980006
			Steel	980006	950816	980006
		Firesleeve	Alum.	980006	630907	980006
Steel	980006		624071	980006		
		Unsleeved	Alum.	980006	950003	980005
			Steel	980006	950668	980005
		Firesleeve	Alum.	980006	630908	980005
Steel	980006		624055	980005		
		Unsleeved	Alum.	980005	950002	980005
			Steel	980005	950680	980005
		Firesleeve	Alum.	980005	630909	980005
Steel	980005		624036	980005		

### -12 through -32 Flared AN818 Swivel Nut Fittings and Assemblies

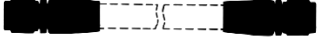
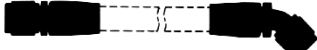
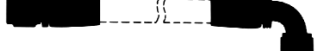
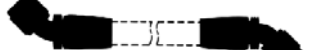
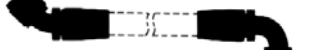
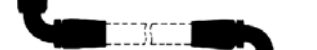
Fitting A	Fitting B	Type	Material	Fitting A Part No.	Assembly Base No.	Fitting B Part No.
		Unsleeved	Alum.	91	360	491
			Alum.	451	390A	451
			Steel	491	350	491
		Firesleeve	Alum.	491 or 451	624000	491 or 451
			Steel	491 or 451	624000	491 or 451
		Unsleeved	Alum.	491 or 451	950234	980136
			Steel	491 or 451	950234	980136
		Firesleeve	Alum.	491 or 451	624037	980136
Steel	491 or 451		624037	980136		
		Unsleeved	Alum.	491 or 451	950192	980137
			Steel	491 or 451	950192	980137
		Firesleeve	Alum.	491 or 451	624066	980137
Steel	491 or 451		624066	980137		
		Unsleeved	Alum.	980136	950247	980136
			Steel	980136	950817	980136
		Firesleeve	Alum.	980136	624089	980136
Steel	980136		630910	980136		
		Unsleeved	Alum.	980136	950233	980137
			Steel	980136	950818	980137
		Firesleeve	Alum.	980136	630911	980137
Steel	980136		624912	980137		
		Unsleeved	Alum.	980137	950248	980137
			Steel	980137	950819	980137
		Firesleeve	Alum.	980137	630905	980137
Steel	980137		630913	980137		

# 303, 302A Medium Pressure, Flareless Fittings and Assemblies

## Globeseal Flareless

- 950532 Assembly
- To mate with MS33514, MS33515, AS33514, AS33515

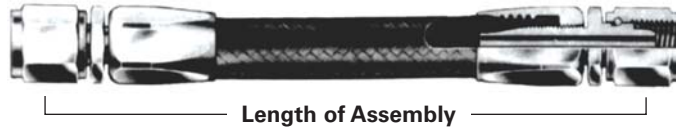

## Material & Finish:

Nut and nipple, sizes 4 through 6, cadmium-plated steel. Nut and nipple sizes 8 and up, and socket, anodized aluminum. All materials and finishes conform to applicable specifications for end fittings used in aircraft fluid systems.

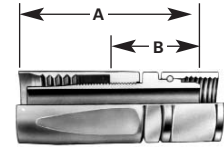

440  
Hose Fitting

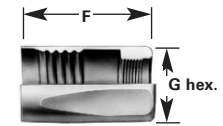

(K = distance across corners)  
210, 215, Socket

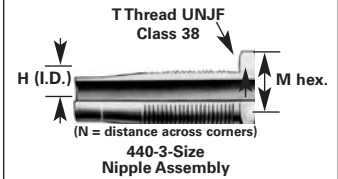

440-3-Size  
Nipple Assembly

HOSE FITTING (Globeseal)				SOCKET			NIPPLE ASSEMBLY (Globeseal)					
Part No.	Max. Dim. A	Dim. B	Weight (lbs.)	Part No.	Dim. F	Dim. G	Max. Dim. K	Part No.	Min. Dim. H	Dim. M	Max. Dim. N	Thread T
440-4	1.78	.94	.068	210-4D	1.100	.625	.693	440-3-4	.170	.562	.65	7/16 - 20
440-5	1.92	1.05	.081	210-5D	1.200	.688	.755	440-3-5	.232	.625	.72	1/2 - 20
440-6	2.11	1.11	.122	210-6D	1.300	.812	.880	440-3-6	.295	.688	.80	9/16 - 18
440-8D	2.58	1.33	.117	215-8D	1.650	.938	1.005	440-3-8D	.390	.875	1.01	3/4 - 16
440-10D	2.84	1.46	.167	215-10D	1.800	1.125	1.234	440-3-10D	.484	1.000	1.16	7/8 - 14
440-12D	3.14	1.47	.222	215-12D	2.100	1.250	1.359	440-3-12D	.608	1.250	1.45	1 1/16 - 12
440-16D	2.97	1.60	.286	212-16D	1.661	1.438	1.546	440-3-16D	.810	1.500	1.74	1 5/16 - 12
440-20D	3.17	1.72	.503	212-20D	1.750	1.750	1.921	440-3-20D	10.42	2.000	2.33	1 5/8 - 12
440-24D	3.49	1.94	.606	212-24D	1.845	1.938	2.124	440-3-24D	1.276	2.250	2.62	1 7/8 - 12

All dimensions in inches.

## Globeseal Flareless Assemblies

Fitting A	Fitting B	Type	Material	Fitting A Part No.	Assembly Base No.	Fitting B Part No.
		Unsleeved	Alum. Steel	440 440	950532 950532	440 440
		Firesleeve	Alum. Steel	440 440	630943 630942	440 440
		Unsleeved	Alum. Steel	440 440	950781 950781	980688 980688
		Firesleeve	Alum. Steel	440 440	630945 630944	980688 980688
		Unsleeved	Alum. Steel	440 440	950645 950645	980569 980569
		Firesleeve	Alum. Steel	980688 980688	630947 630946	980569 980569
		Unsleeved	Alum. Steel	980688 980688	950785 950782	980688 980688
		Firesleeve	Alum. Steel	980688 980688	630949 630949	980688 980688
		Unsleeved	Alum. Steel	980688 980688	950786 950783	980569 980569
		Firesleeve	Alum. Steel	980688 980688	630951 630950	980569 980569
		Unsleeved	Alum. Steel	980569 980569	950787 950784	980569 980569
		Firesleeve	Alum. Steel	980569 980569	630953 630952	980569 980569

# Aircraft Rubber Hose Assembly Instructions

## 306, 303 and 302A Hose

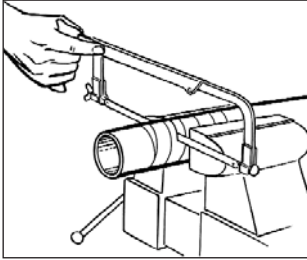

### Step 1.

Cut hose squarely to length. Use hose cut-off machine or fine tooth hacksaw. Do not remove the cover if using a hacksaw; wrap hose with several layers of tape before cutting.

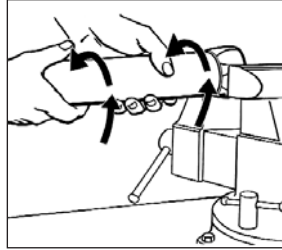

### Step 2.

Place socket in vise. Do not over-tighten vise on thin walled sockets of lightweight fittings. Screw hose counter-clockwise into socket until it bottoms. Back off 1/4 turn.

### Step 3.

Tighten nipple and nut on assembly mandrel. The use of Aeroquip brand S1051 hand assembly tools are recommended to avoid damage to the sealing surface and to properly support the inner tube.

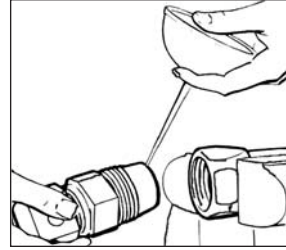

### Step 4.

Lubricate inside of hose and nipple threads liberally. Use lubricating oil, petrolatum or light grease.

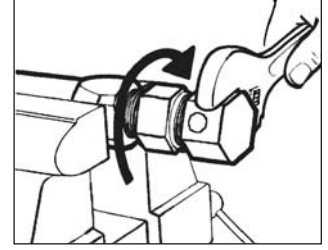

### Step 5.

Screw nipple into socket and hose using wrench on assembly tool hex. Nut must swivel freely when assembly tool is removed. Maximum allowable gap between nut and socket is 1/16". On -32 screw in until turning becomes difficult, back out nipple, relubricate and reassemble.

## Elbow Hose Assemblies - 303 and 302A

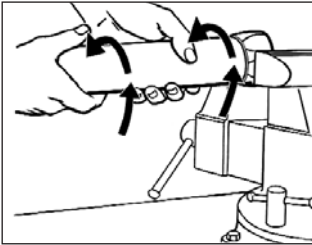

### Step 1.

Cut hose squarely to length. Use hose cut off machine or fine tooth hacksaw. If using a hacksaw, wrap hose with tape before cutting. Do not remove cover.

### Step 2.

Place socket in vises. Do not over-tighten vise on thin walled sockets of light weight fittings. Screw hose counter-clockwise into socket until it bottoms. Back off 1/4 turn.

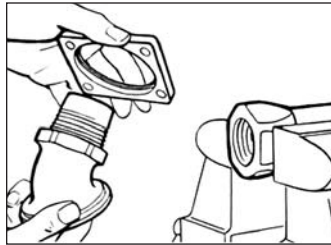

### Step 3.

Flange elbow fittings. Drop flange over threaded end of nipple. Nipple shoulder must fit into counter bore of flange.

### Step 4.

Lubricate inside of hose and nipple threads liberally. Use lubricating oil, petrolatum or light grease.



### Step 5.

Screw nipple into socket and hose using wrench on elbow hex. Tighten until hex is snug against socket. On -32 and larger sizes, screw in until turning becomes difficult, back out nipple, relubricate and reassemble.

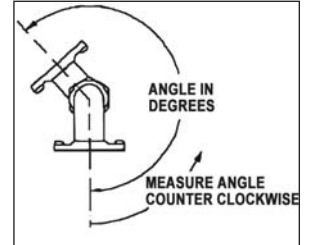

### Step 6.

Adjustments may be necessary to obtain the desired position angle between two elbows. In order to minimize backing off elbows to position, the following procedure should supplement Step 5.

- A. Tighten both elbows to maximum allowable gap (reference Step 6C), then start to position for relative angle between the elbows.
- B. Finish assembly by adjusting both elbows. Backing-off to position should be avoided and in no case should exceed 1/4 turn.
- C. Maximum allowable gap between nipple hex and socket is 1/16" using 303 and 302A hose.

# Hose Cut-off Factors

Cut off factors shown below indicate difference (in inches) between Length "L" and Length "J" illustrated on sample hose assembly.

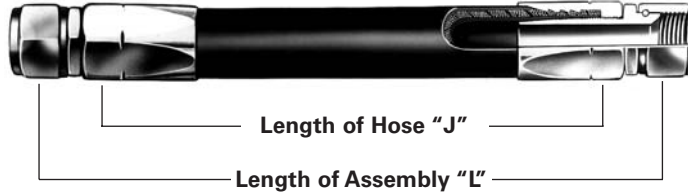

				HOSE DASH SIZE											
		HOSE	ASSEMBLY	-2	-3	-4	-5	-6	-8	-10	-12	-16	-20	-24	-32
<b>Low Pressure</b>	306	Flared Fittings	Straight Swivel to Straight Swivel	.80	.88	.94	—	1.08	1.34	1.44	—	—	—	—	—
<b>Medium Pressure</b>	302A 303	Flared Fittings	Straight Swivel to Straight Swivel	—	1.32	1.30	1.50	1.54	1.90	2.02	2.02	1.90	2.00	2.18	2.50
	302A 303	Globeseal Flareless Fittings	Straight Swivel to Straight Swivel	—	—	1.88	2.10	2.22	2.66	2.92	2.94	3.20	3.44	3.88	4.74



# Rubber Hose Assembly Equipment

## S1385 Hose Cutoff Saw



### S1385 Features

- Low Cost
- Compact
- Easy Operation
- Bench-Mounted
- Built-in Safety Features
- U.L. Listed

### Electrical Requirements

2 1/2 horsepower electric motor. 115V, single phase, AC-DC, 5-60 Hz, 5200 rpm.

Eaton's Aeroquip brand S1385 hose cutoff saw is compact and easy to operate. The spring arm is designed with an improved stabilizer to insure fast and efficient cutting of hydraulic hoses. The S1385 saw will cut single wire braid hoses through 1.25 inches and 2-wire braid hoses through 1 inch as well as textile hoses through 2 inches.

The S1385 cutoff saw is easily bench-mounted eliminating the need for a special stand. It is also equipped with a safety clutch to prevent motor damage in case of binding. The blade is well guarded and can easily be changed. See brochure AEB-262 for more details.

## S1380 Hose Assembly Machine



### Machine Specifications

*Dimensions:* 12" high x 34" long x 27" wide

*Weight:* 200 lbs. (approx.)

*Hose Range:* -3 (3/16") through -12 (3/4"), medium pressure -4 (1/4") through -12 (3/4"), high pressure

*Motor Power:* 1 horsepower

### Electrical Requirements

230/460V, 3 phase, 60 cycle, 120V

Eaton designed the S1380 hose assembly machine to simplify and speed the assembly of hoses with standard screw together reusable fittings. The machine features a durable 1 H.P., 3-phase, 60 cycle electric brakemotor operating at 1750 R.P.M. The motor is "C" face mounted to a speed reducer which provides a working spindle with 58.3 R.P.M. . With the S1380 machine you can quickly assemble straight or elbow-type reusable fittings on medium pressure hoses in sizes -3 (3/16") through -12 (3/4") and high pressure hoses in sizes -4 (1/4") through -12 (3/4"). This hose assembly machine is simple to operate with an easily adjusted spindle lock for changing mandrels or operations and a carriage vise for accurate fitting assembly. The complete machine comes with two sets of chuck jaws, fire mandrels and operator's manual. See brochure AEB-257 for complete information.

FAILURE OR IMPROPER SELECTION, USE, OR ASSEMBLY OF THE PRODUCTS AND COMPONENTS FOR APPLICATIONS DESCRIBED HEREIN CAN RESULT IN POSSIBLE PROPERTY DAMAGE, PERSONAL INJURY OR DEATH.

This document and any other related information from Eaton® Aeroquip® or its affiliates and authorized distributors, provide product options for consideration by Users having technical expertise with these products. Due to the wide variety of applications and operating conditions for these products and components, the User is solely responsible for making the final selection of the products and ensuring that all performance, safety and warning requirements for the User's intended application are met. Eaton® Aeroquip® recommends that Eaton® Aeroquip® hose, fittings or assembly equipment must be used only with other Eaton® Aeroquip® hose, fittings or assembly equipment, and Eaton

Aeroquip and/or its affiliates disclaim any obligation or liability (including all incidental and consequential damages) to the extent Eaton® Aeroquip® hose, fittings or assembly equipment is used with any other manufacturer's hose, fittings or assembly equipment or in the event that Eaton® Aeroquip® recommended processes and product instructions for hose assemblies are not followed. The products described herein, including product features, specifications, designs, and availability are subject to change at any time without notice.

Eaton LTD  
**Fluid Conveyance**  
Posttach 1026  
Carl-Benz-Strasse 9  
D-82205 Gilching  
Germany  
Phone: (49) 810-575-0  
Fax: (49) 810-575-27  
[www.aerospace.eaton.com](http://www.aerospace.eaton.com)

Eaton LTD  
**Fluid Conveyance**  
Chemin De Pau  
64121 Serres-Castet  
France  
Phone: (33) 559-333-864  
Fax: (33) 559-333-865  
[www.aerospace.eaton.com](http://www.aerospace.eaton.com)

Eaton Corporation  
**Fluid Conveyance**  
300 South East Avenue  
Jackson, Michigan 49203-1972  
Phone: (517) 787-8121  
Fax: (517) 787-5758  
[www.aerospace.eaton.com](http://www.aerospace.eaton.com)

Eaton Corporation  
**Fluid Conveyance**  
Meadowbrook Road  
P.O. Box 819  
Toccoa, Georgia 30577-0819  
Phone: (706) 779-3351  
Fax: (706) 779-2638  
[www.aerospace.eaton.com](http://www.aerospace.eaton.com)

Eaton Corporation  
**Fluid Conveyance**  
2500 W. Argyle St.  
P.O. Box 1845  
Jackson, MI 49202-1845  
Phone: (517) 787-8121  
Fax: (517) 789-4716  
[www.aerospace.eaton.com](http://www.aerospace.eaton.com)

Eaton LTD  
**Fluid Conveyance**  
Broad Ground Road  
Lakeside  
Redditch  
Worcs B98 8YS  
England  
Phone: (44) 152-751-7555  
Fax: (44) 152-751-7556  
[www.aerospace.eaton.com](http://www.aerospace.eaton.com)

